

Heat Seal Wrapper



We have hot plate assembly kits, thermostats, element assemblies, bearing block sets, and many more parts for Heat Seal wrapper.



This image is only for reference and not affiliated with manufacture.



Fits Model: 102A



Standard 115V Power Supply Solid State Controlled Film, Cut Off Rod 6" by 15" Thermostatically controlled Hot Plate with Non-Stick, Replaceable Teflon Cover. Heavy Gauge Aluminum





















Base Aluminum and Stainless Steel Construction. Stainless Steel Wrapping Surface, Stretch Film - 18" Maximum Width Available in 2 Roll

Heat Seal 102A Wrapping Machine

SKU#: HEAT SEAL 102A



Model 102A Parts List

Image	Sku #	Description
	Sku#: HSW735	6" x 15" Hot Plate Assembly Kit, 110V with Thermostat, Element, HD Plate, Wires & Non-stick Replaceable Cover (OEM# 6101020)
	Sku#: HSW725	Fuse Holder, ¼ Quick Disc., HKP-HH (Replaces old # 1821013)
	Sku#: HSW724	Circuit Control Board
	Sku#: HSW737	8" x 15" Hot Plate Assembly Kit, 110V with Thermostat, Element, HD Plate, Wires & Non-stick Replaceable Cover (OEM# 6102043)
	Sku#: HSW720	B200 Thermostat
	Sku#: HSW723	1 Amp MDA Fuse Slo-Blo
	Sku#: HSW730	Element Assembly
	Sku#: HSW703	15Amp Toggle Switch, 125V
	Sku#: HSW727	Rectangular Red Pilot Light 125V (Replaces old # 1836002)
	Sku#: HSW726	23" Long Cut-Off Rod
	Sku#: HSW707	Bearing Block Set, Table/Floor Model (OEM# 630518)
	Sku#: HSW740	Element Retainer Plate (OEM# 6305080)
	Sku#: HSW718	Film Core Axle 5/8" x 21 15/16" Long
	Sku#: HSW704	5 Foot 16/3 SJT Power Cord with Cap
	Sku#: HSW713/714	White 3" Core Adapter Set
	Oem#: HSW738	3" Aluminum Core Adapter Kit
	Sku#: HSW738	8" x 15" Fabricated Hot Plate (OEM# 6305079)
	Sku#: HSW721	B200 Thermostat Knob
	Sku#: HSW741	Seal Plate Wire Harness Kit (3 Wires) (OEM# 6305041)

TO REMOVE ELECTRICAL BOX:

- Lift up wrapping bridge (A)
- Remove screws (B) from both sides of electrical control housing (C)
- Lift out electrical control housing

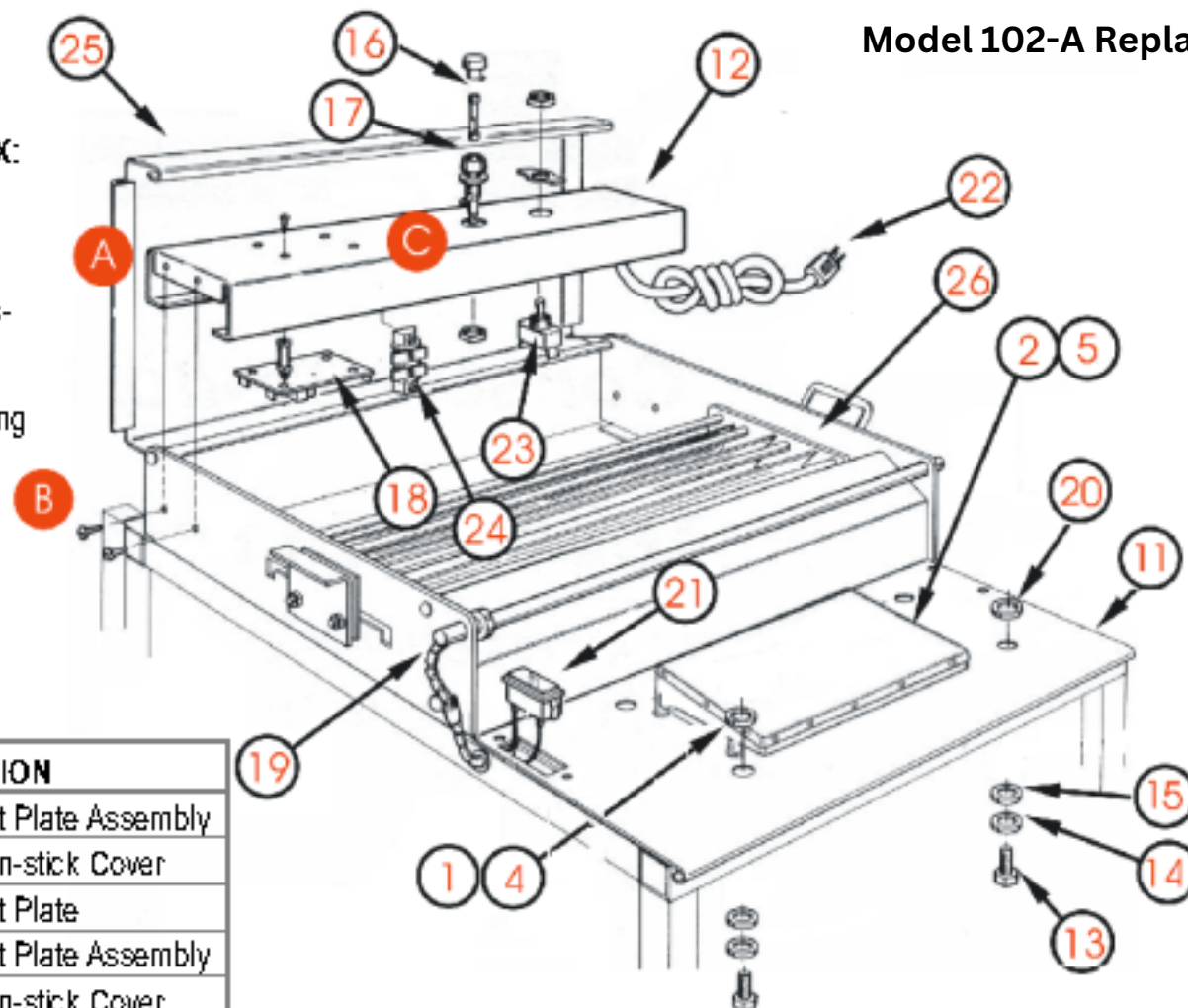

ITEM	PART #	DESCRIPTION
1	6101-020	6" x 15" Hot Plate Assembly
2	5901-011	6" x 15" Non-stick Cover
3	6107-147	6" x 15" Hot Plate
4	6102-043	8" x 15" Hot Plate Assembly
5	5901-001	8" x 15" Non-stick Cover
6	6305-079	8" x 15" Hot Plate
7	2145-023	Thermostat Knob
8	1881-002	Thermostat
9	6110-016	Element Assembly
10	6305-080	Retainer Plate
11	6102-063	Front Plate
12	6102-031	Control Housing
13	1903-188	#10-32 Screw
14	1907-005	#10 Lock Washer
15	1909-026	#10 Flat Washer
16	1821-034	1 Amp Fuse, Slo-Blb
17	1821-013	Fuse Holder
18	1818-001	Control Board
19	1824-011	Hot Rod 23" L
20	1833-002	Insulator Washer
21	6108-000	Pilot Light
22	1851-052	Power Cord
23	1872-008	Toggle Switch
24	1875-002	Terminal Block
25	6102-052	Wrapping Bridge
26	6102-050	Film Selector Assy.

6" X 15" HOT PLATE FOR MODEL 102

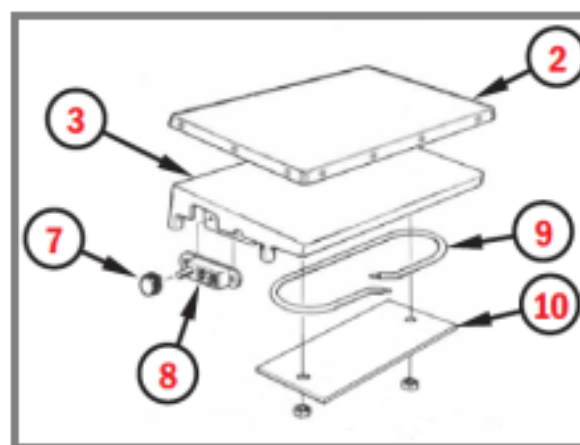

8" X 15" HOT PLATE FOR MODELS 104, 107

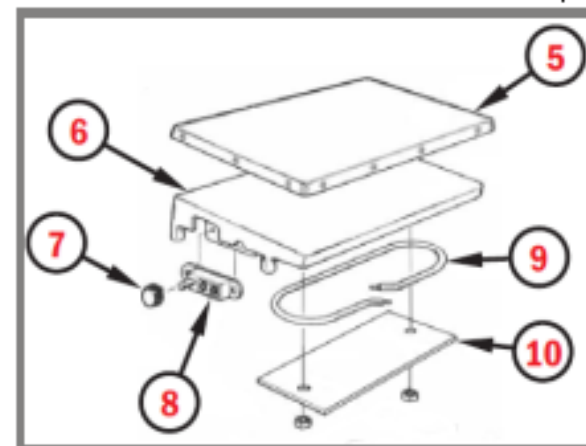



FEATURES

- Standard 115V Power Supply
- Thermostatically controlled Hot Plate with Non-Stick, Replaceable Cover
- Solid State Controlled Film Cut Off Rod
- Splash Shield
- Heavy Gauge Welded Aluminum Frame
- Aluminum and Stainless Steel Construction
- 201 - 16 Gauge Stainless Steel Wrapping Bridge Constructed of NSF/ANSI 51-2012 Approved Materials
- Adjustable Foot Pads for Easy Leveling on Uneven Floors
- Easy to Use Film Selector Feature
- Adjustable Film Tension

MODEL SPECS

FILM CAPACITY	Two 18" Rolls - 102A Three 18" Rolls - 107A
HOT PLATE	6" x 15" - 102A 8" x 15" - 107A
OVERALL DIMENSIONS	26" D, 23" W, 38" H 66 D, 58.4 W, 96.5 H cm
WORKING HEIGHT	36" (91cm)
POWER REQUIREMENT	115 Volt, 6.5 Amp, 60 Cycles
WATTAGE	725 Watts
WEIGHT	51 lbs. (24 kg) - 102A 55 lbs. (25 kg) - 107A

AVAILABLE OPTIONS

- 12 Hour Timer
- All Stainless Steel Construction
**Available for 107A Only*
- Removable Power Pack
- 220 Volt Power Supply
- Stainless Steel Wings (W24ST), 24"W, 14"D
**Available for 107A Only*
- Accessory Storage Rack (ASR) 22"W, 14"D, 12"H

HEAT SEAL WRAPPING MACHINE

The Heat Seal Wrapping Machine is a versatile and efficient solution for packaging various products. With its advanced heat sealing technology, it ensures a secure and airtight seal, keeping the contents fresh and protected. This machine is designed to handle a wide range of packaging materials, including plastic films, laminates, and foils. Its user-friendly interface allows for easy operation and precise control over sealing parameters. The Heat Seal Wrapping Machine is an essential tool for businesses looking to streamline their packaging process and deliver high-quality products to their customers.



Fits Model 102A



The above described parts are manufactured and/or supplied by National Band Saw Company as replacement parts for equipment. National Band Saw is not affiliated with any original equipment or parts manufacturers.





HEAT SEAL - 102A

1. The 102A floor model stretch film overwrapper is a versatile and efficient hand wrap machine designed for easy and effective packaging. With a capacity for two rolls of wrap and an 18" film capacity, it allows for seamless wrapping of various items. This overwrapper is equipped with a 6" by 15" hot plate, which is thermostatically controlled and features a non-stick replaceable cover. This ensures precise and consistent heat distribution for optimal wrapping results.
2. This machine is ideal for industries that require high-speed packaging, such as food processing, pharmaceuticals, and cosmetics. It is easy to operate and can be adjusted to accommodate different packaging sizes and shapes.
3. The Heat Seal Wrapping Machine is made of durable materials to withstand continuous use and ensure long-term reliability. It is a cost-effective solution for businesses looking to streamline their packaging process and improve overall efficiency.





Overall Dimensions:

- Width: 23"
- Depth: 26"
- Height: 38"
- Hot Plate: 6" x 15"
- Working Height: 36"

The machine features a solid state controlled cut off rod, which is designed to cut film with ease and precision. It accepts a roll of film up to 18" in length (sold separately) to wrap product for retail sale or later use. To make the cutting and wrapping process as convenient as possible, the unit includes a thermostatically-controlled hot plate. This plate measures 6" x 15" in size and features a replaceable, non-stick cover that prevents film from sticking to the platform and causing a wasteful, time-consuming mess. It's heated too, providing dependable warmth for effortless sealing.

