

Meat Tenderizer



This image is only for reference and not affiliated with manufacture.

We have Lift-Out units, blades, strippers, safety covers, and many more parts for Berkel Tenderizer.



Beef Strips



Tomahawk





Replaces: 4675-010

Fits Model: 703,704,705



The above described parts are manufactured and/or supplied by National Band Saw Company as replacement parts for equipment. National Band Saw is not affiliated with any original equipment or parts manufacturers.

Lift-Out Unit Components

Sku#: BT033

Safety Cover



Sku#: BT020A

Frame Assembly



Sku#: BT021

Blade Frame Assy

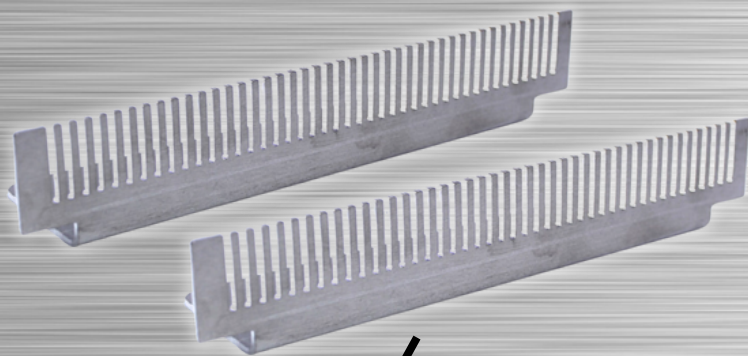

Rear & Front Stripper

Sku#: BT002

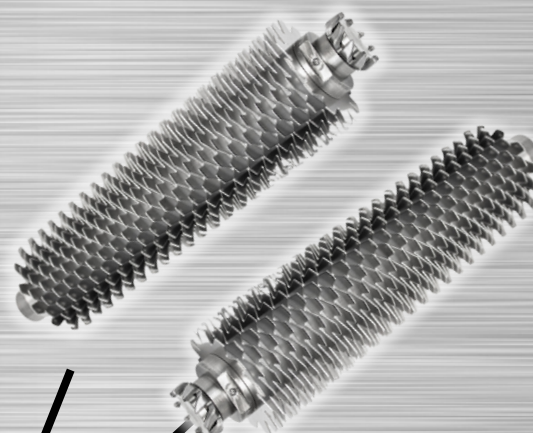

Rear & Front Blade Shaft

Sku#: BT022F, BT023R



Stripper - Stir Fry

Sku#: BT104

Complete Lift Out Unit with Frame, Blades, and Safety Cover

Sku#: BT020A/BT033

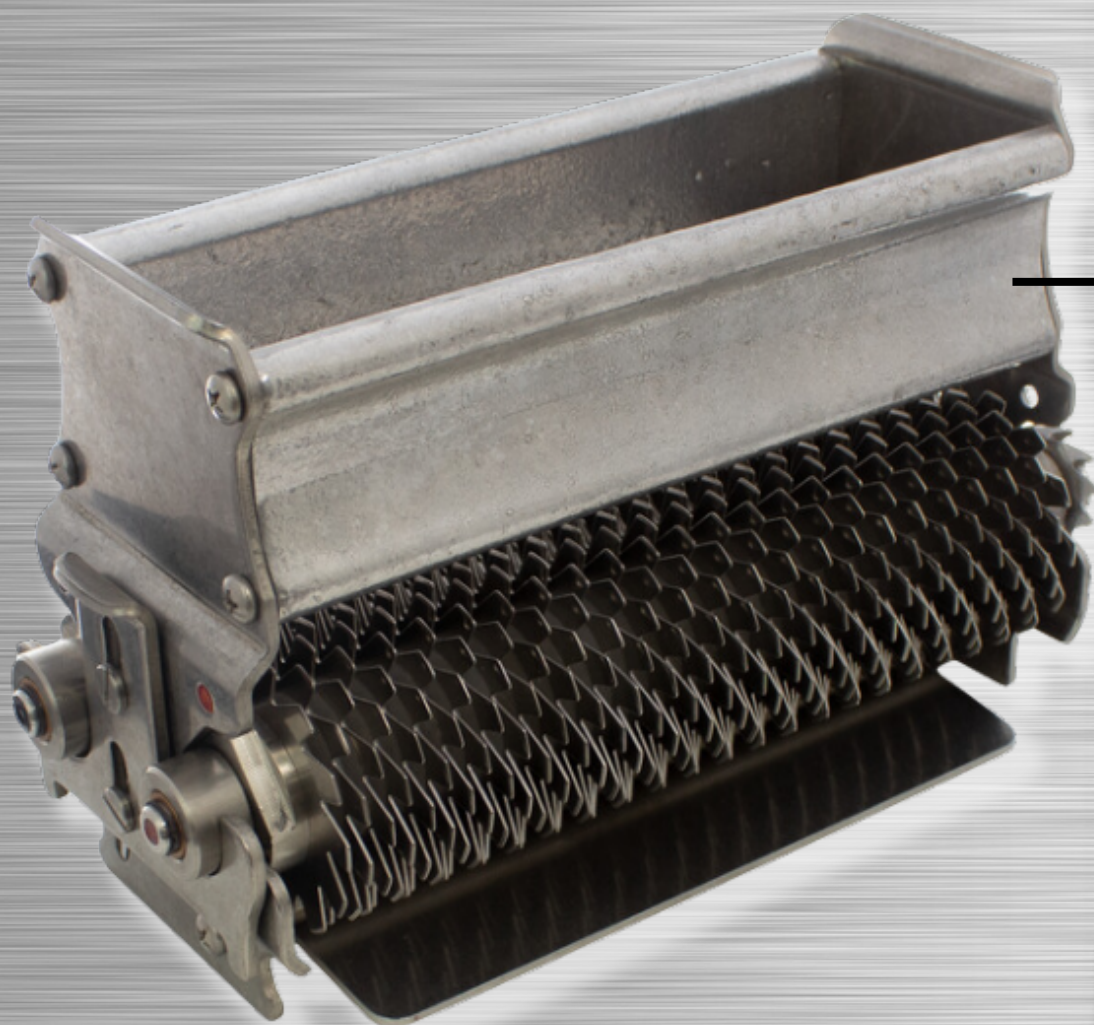

Blade Frame Assy

Front & Rear Shaft/Blade Assy



Plastic Safety Cover
(For Berkel Tenderizer)

Berkel® Tenderizer

Tenderizer

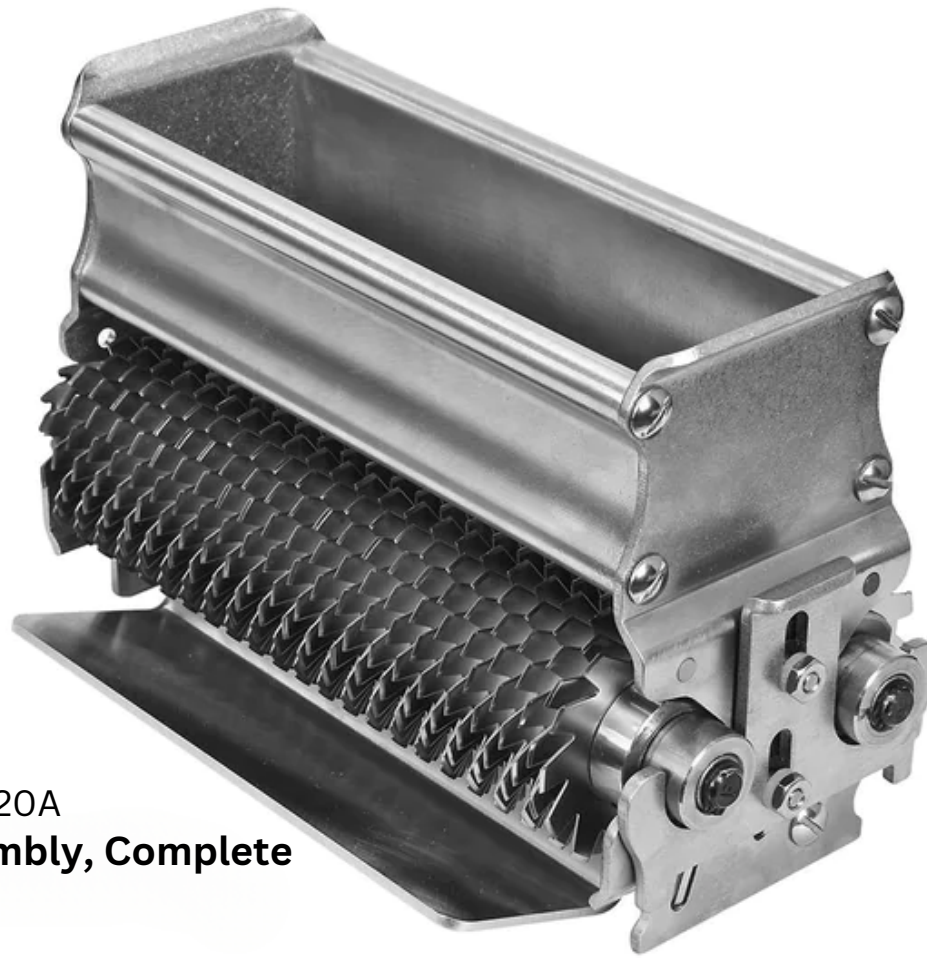

Sku: BT020A
Frame & Blade Assembly, Complete



Sku: BT029
Hardware Kit, Lock Plate

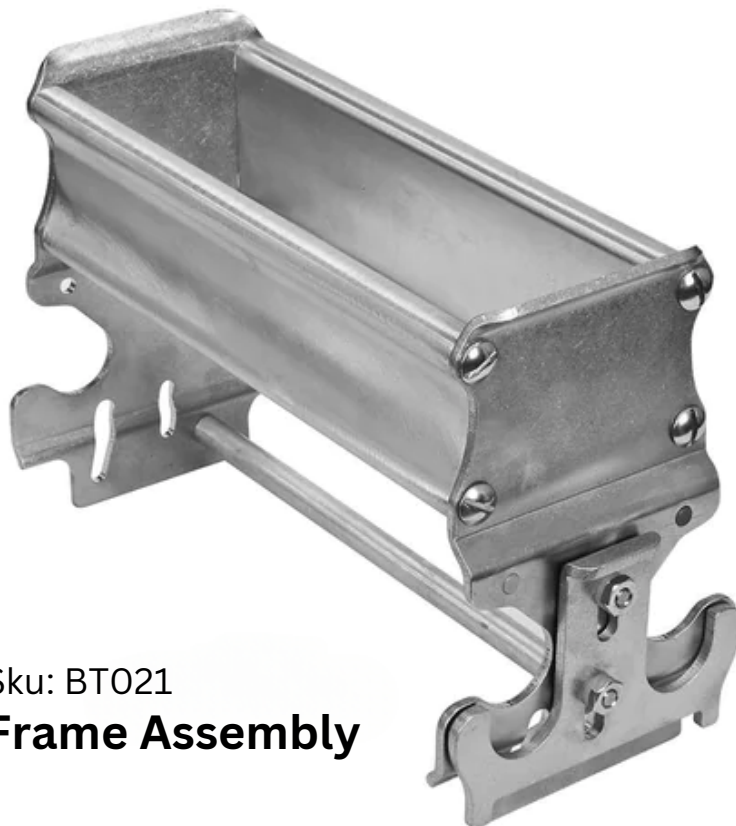

Sku: BT021
Blade Frame Assembly



Sku: BT030
Lock Plate

COMPLETE LIFT OUT UNIT WITH BLADES, STRIPPERS, AND FRAME

Fit For Berkel Tenderizer 703, 704, 705 Replaces 4675-0103

Use this lift out unit assembly to enhance the texture and tenderness of chicken breast, veal, or squid by gently piercing the product without tearing and reducing cooking time by up to 40%. Say goodbye to chewy and tough meat, and hello to tender and juicy results. Elevate your culinary skills with this essential kitchen tool.

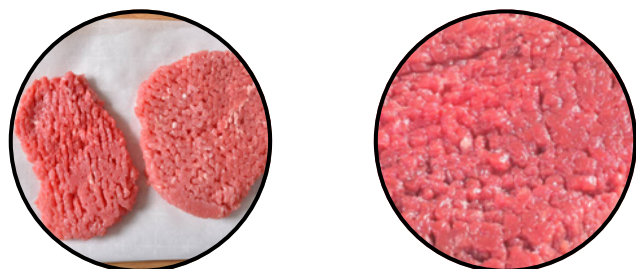

The above described parts are manufactured and/or supplied by National Band Saw Company as replacement parts for equipment. National Band Saw is not affiliated with any original equipment or parts manufacturers.





Complete Frame Assembly With Safety Cover For Berkel Tenderizer 703, 704, 705

- 1. Introducing our Meat Tenderizer Unit, a must-have tool for every kitchen. This innovative device is designed to effortlessly tenderize meat, making it more succulent and flavorful.
- 2. With its sturdy construction and ergonomic handle, our Meat Tenderizer Unit ensures easy and comfortable use. Its sharp stainless steel blades penetrate the meat, breaking down tough fibers and allowing marinades and seasonings to penetrate deeply.
- 3. The Meat Tenderizer Safety Cover is a must-have accessory for any kitchen.
- 4. Designed to ensure safe and efficient meat tenderizing, this cover provides a protective barrier between your hand and the sharp blades of the tenderizer.

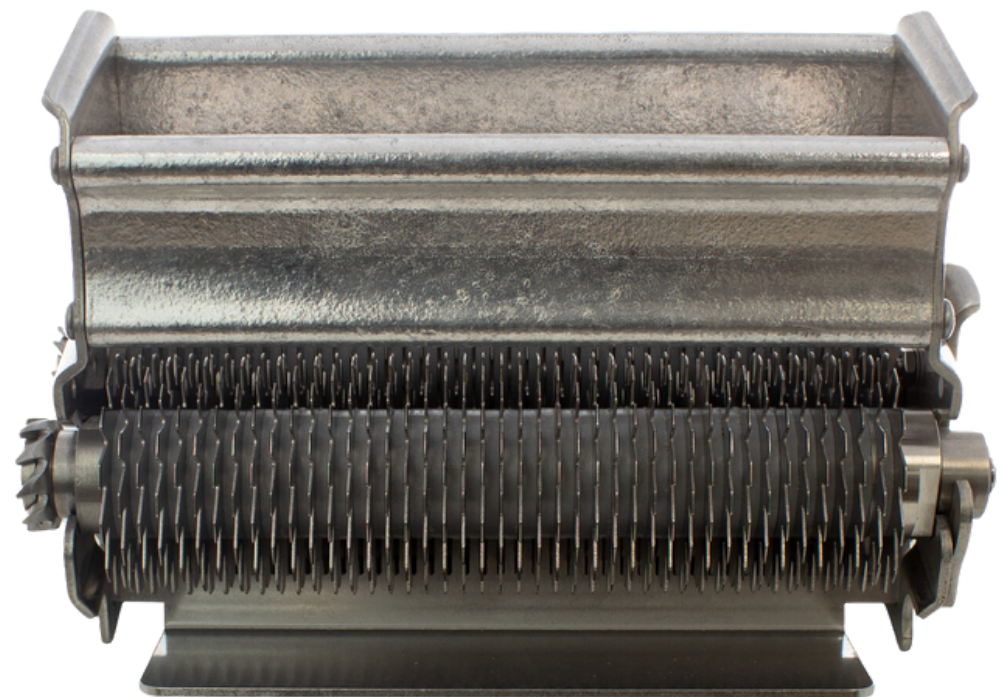

The above described parts are manufactured and/or supplied by National Band Saw Company as replacement parts for equipment. National Band Saw is not affiliated with any original equipment or parts manufacturers.

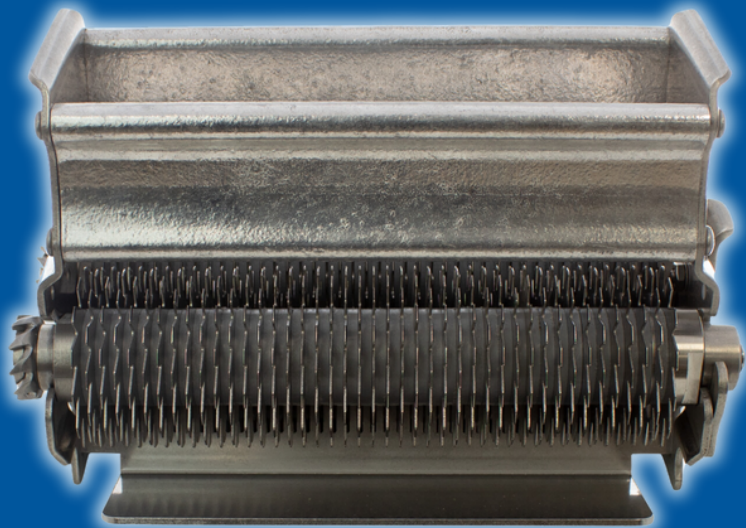
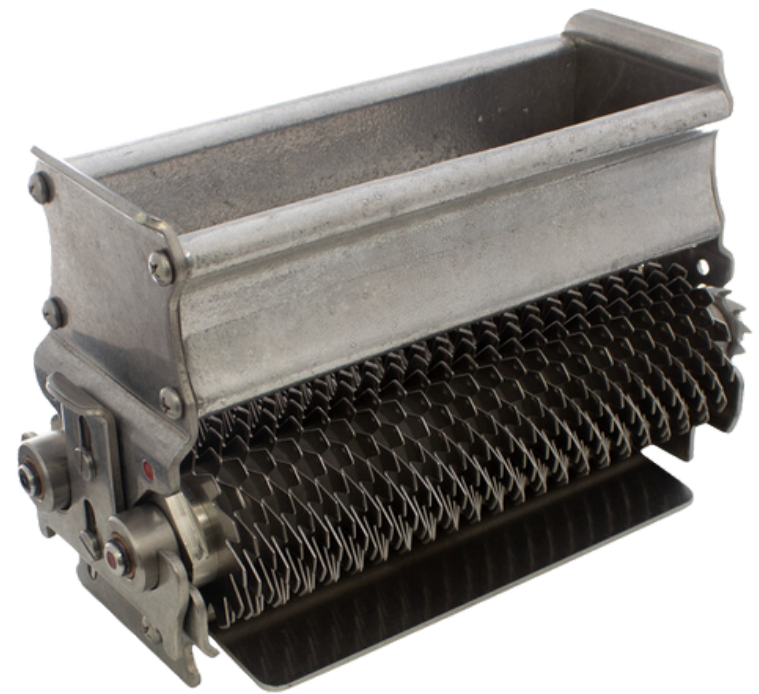

Turn your tenderizer into a kneading machine by changing the position of the rear stripper and feed 2-3 smaller pieces of hard-to-merchandise pieces to form one value-added kneaded steak.

Designed to enhance the functionality of your tenderizer, this attachment allows you to effortlessly knead dough for bread, pizza, and other baked goods.

